

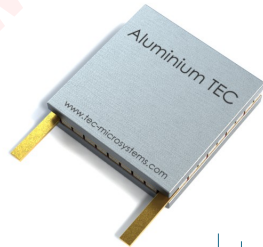

### THERMOELECTRIC COOLER PERFORMANCE



$\Delta T_{max}$ K	$Q_{max}$ W	$I_{max}$ A	$U_{max}$ V	ACR Ohm	Ambient Temperature	Conditions
69	29.4	8.4	5.9	0.5	+27°C / 300K	Vacuum
74	31.8	8.2	6.5	0.6	+50°C / 323K	Dry N2
79	34.0	8.0	7.0	0.6	+75°C / 348K	Dry N2
81	34.8	7.9	7.2	0.7	+85°C / 358K	Dry N2

Note: Thermoelectric Cooler performance values are specified for optimal conditions, assuming that TEC hot side ( $T_{hot}$ ) is stabilized at ambient temperature ( $T_{amb}$ )

### TECHNICAL DRAWING

1MA10-049-05

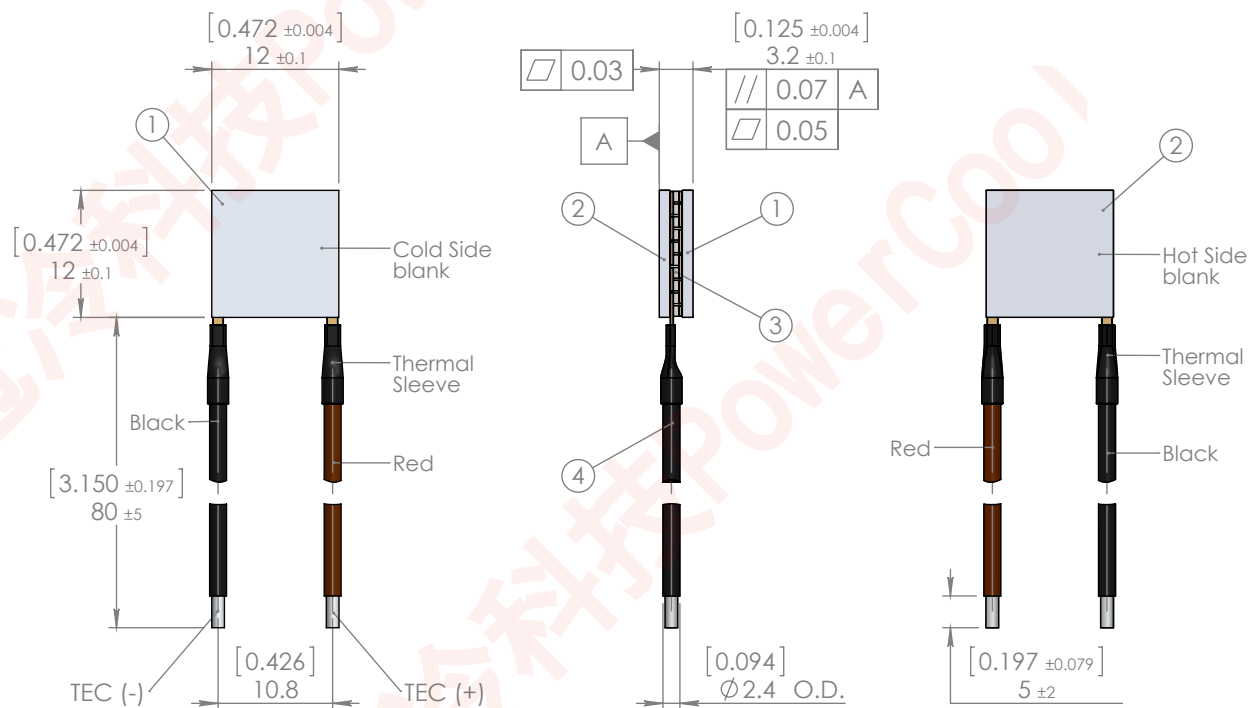

Dimensions are in mm  
Dimensions in [ ] are in inches

### TEC DESCRIPTION

### KEY FEATURES

- Cold Side (1) and Hot Side (2): bare Aluminium
- Internal Assembly: Solder Sn-Sb ( $T_{melt}=230^{\circ}C$ )
- Cold Side (1) Surface: blank
- Hot Side (2) Surface: blank
- Terminal Contacts (4): AWG-18 Wires, silicon insulated color-coded (Red/Black), multi-strand
- Bi-Te Material (3): high-grade, hot-extruded type
- Protective Coating: available by request
- Laser marking: available by request

- High-Density (HD) pellets placement technology
- Up to 30W/cm<sup>2</sup> TEC Cooling Power density
- Tested to 1M cycles, ideal for cycling applications
- TELCORDIA GR-468 (MIL-883) qualified
- Aluminium (metal) plates instead of ceramics
- Up to 225°C short time processing (for mounting)
- Additional manufacturing options (see Pages 3,4)
- RoHS EU Compliant
- REACH EU Compliant



PERFORMANCE PLOTS

@27°C, Vacuum	$\Delta T_{max}$ K	$Q_{max}$ W	$I_{max}$ A	$U_{max}$ V
1MA10-049-05	69	29.4	8.4	5.9

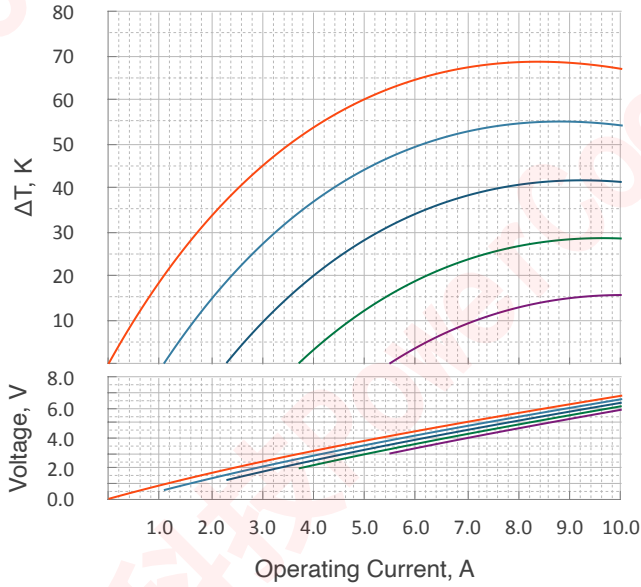

Heatload, W	0.0	5.9	11.8	17.7	23.6
% from $Q_{max}$	0%	20%	40%	60%	80%

@50°C, Dry N2	$\Delta T_{max}$ K	$Q_{max}$ W	$I_{max}$ A	$U_{max}$ V
1MA10-049-05	74	31.8	8.2	6.5

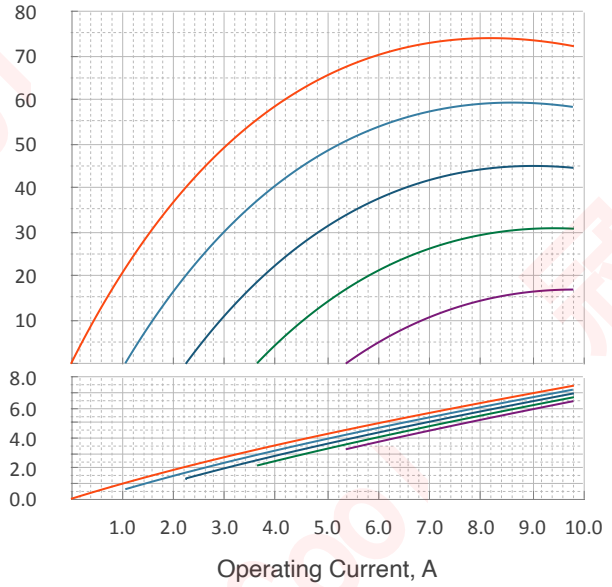

Heatload, W	0.0	6.4	12.7	19.1	25.4
% from $Q_{max}$	0%	20%	40%	60%	80%

@75°C, Dry N2	$\Delta T_{max}$ K	$Q_{max}$ W	$I_{max}$ A	$U_{max}$ V
1MA10-049-05	79	34.0	8.0	7.0

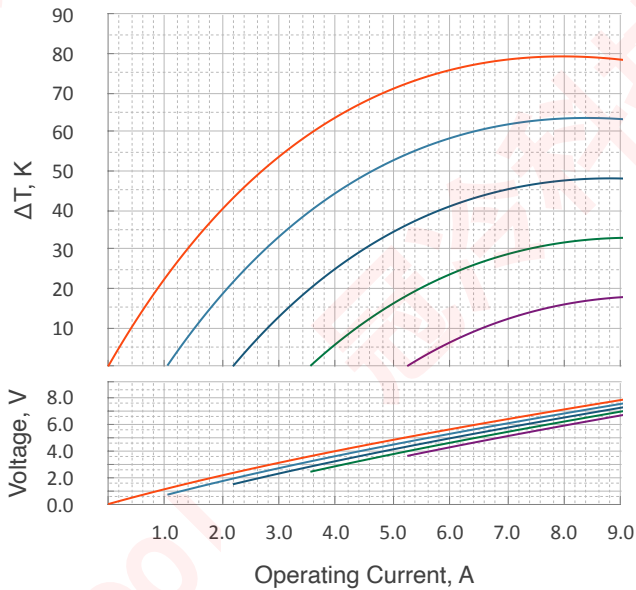

Heatload, W	0.0	6.8	13.6	20.4	27.2
% from $Q_{max}$	0%	20%	40%	60%	80%

@85°C, Dry N2	$\Delta T_{max}$ K	$Q_{max}$ W	$I_{max}$ A	$U_{max}$ V
1MA10-049-05	81	34.8	7.9	7.2

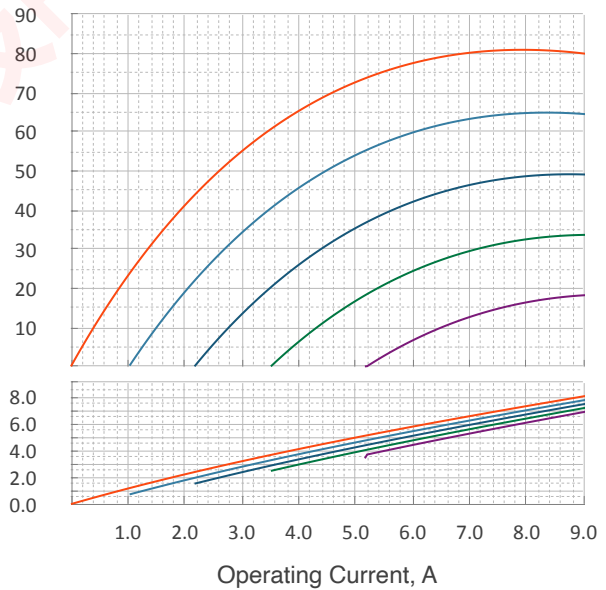

Heatload, W	0.0	7.0	13.9	20.9	27.8
% from $Q_{max}$	0%	20%	40%	60%	80%

Note: Thermoelectric cooler performance values and plots are specified at optimal conditions, assuming TEC hot side is stabilized at ambient temperature ( $T_{hot}=T_{amb}$ ). The performance data is specified for four most common ambient condition modes. Please, contact TEC Microsystems GmbH directly for estimations under different conditions, if required.



### TEC TERMINAL CONNECTION OPTIONS

Silicon insulated AWG-18 color-coded wires (Red/Black)

Blank Copper Lamellas

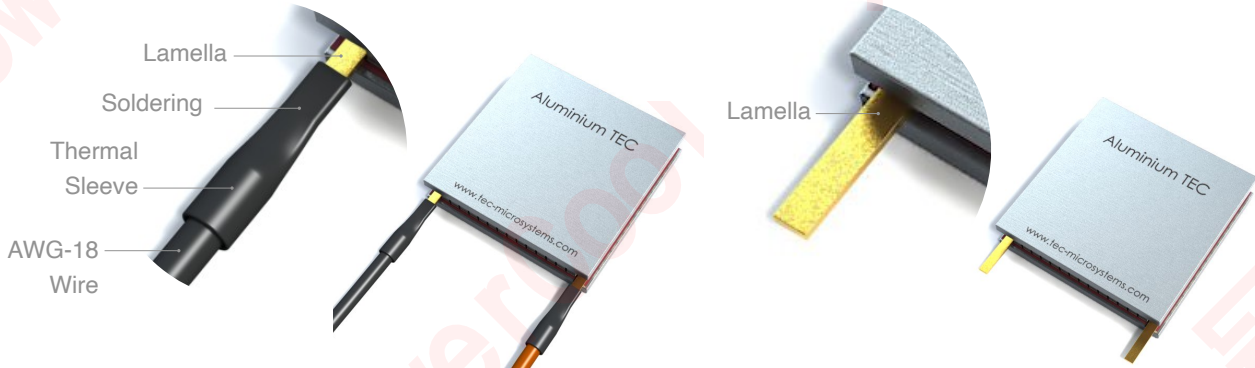

- By default thermoelectric cooler is provided with silicon insulated AWG-18 flexible multicore terminal wires. The alternative configuration with terminal lamellas is a free option, if TEC terminal wires are customised or have to be soldered by Customer later.

### MOISTURE PROTECTION (OPTIONAL TEC PROTECTIVE COATING)

- ✓ Thin fluoropolymer protective layer
- ✓ No impact on TEC performance
- ✓ Non-toxic
- ✓ Covers ALL inner TEC surfaces
- ✓ Withstands up to 220°C processing
- ✓ VOC-free

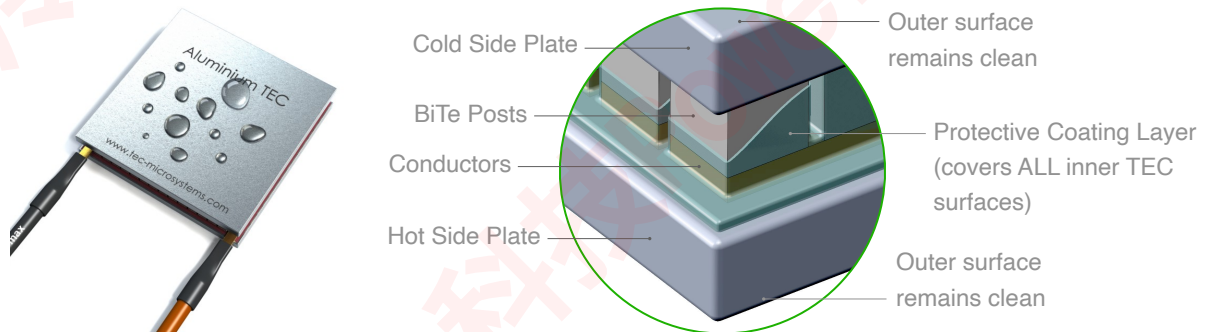

### SURFACE LASER MARKING (OPTIONAL)

TEC Laser engraving is an option provided by request. Aluminium plates are easy to process with laser engraving - TEC polarity marks, text/labels, serial numbers, position marks and etc. Can be applied for both TEC sides, top and bottom.

Laser engraving with individual serial number can be provided together with individual QC protocol (ACR, Figure-of-Merit and Time Constant specified for each TEC unit).

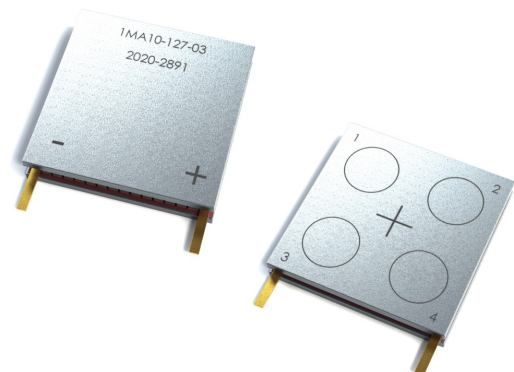



### ADVANCED MOUNTING SOLUTION

Standard manufacturing configuration (default)

Optional solution with mounting holes

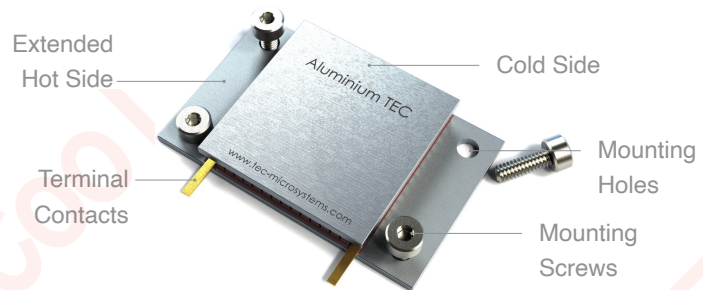
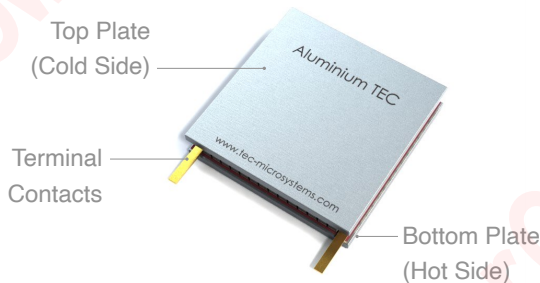

- By default Aluminium TECs from 1MA10 Series have the same size of top and bottom plates. Both plates are made from Aluminium, the recommended mounting methods are gluing and mechanical mounting with a thermal grease. TEC hot side (or both TEC plates) can be extended and provided with holes for screw mounting.

### DEEP CUSTOMIZATION AND OPTIMISATION FOR APPLICATION

Using metal plates instead of ceramics in thermoelectric cooler construction brings the entirely new dimension in TEC optimisation for a final application. Aluminium is easy to machine, thus the advanced options like variable thickness, surface milling, cutout, partial and through- holes, screw mounting and complex 3D surfaces are possible.

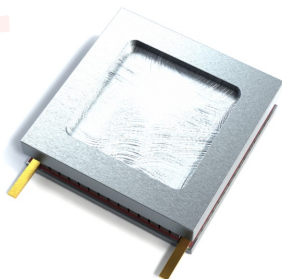

Advanced TEC plates machining

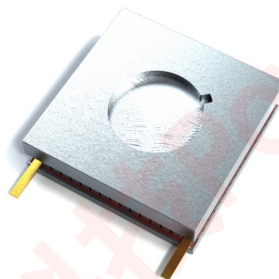

TEC partial and through-holes (single- or multiple)

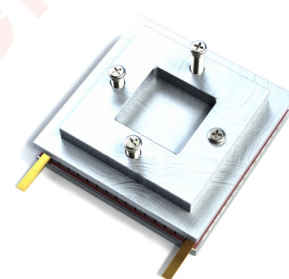

Advanced 3D surface machining & mounting

### ADVANCED TEC MODIFICATIONS FOR NON-FLAT OBJECTS

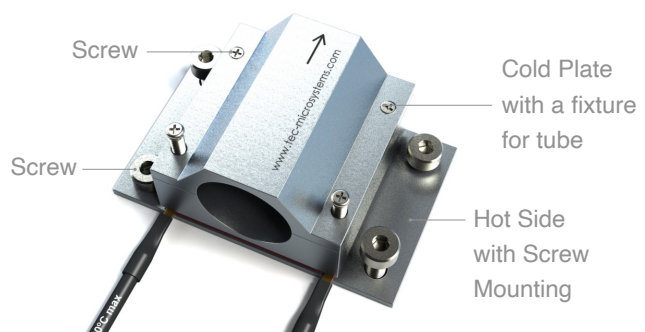
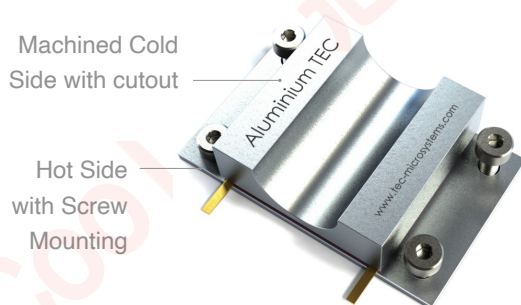

With metal plates in TEC design it's possible to create special configurations for non-flat objects, like tubes.



## 1MA10 SERIES THERMOELECTRIC COOLERS OVERVIEW

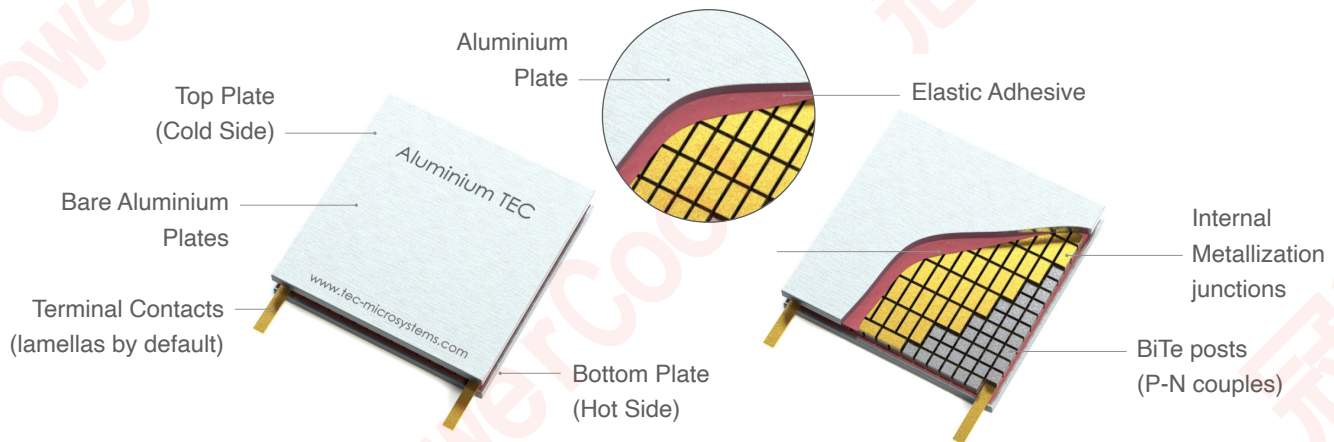

- 1MA10 Series Thermoelectric Coolers have a unique construction with Aluminium plates instead of ceramics.
- Ultimate fusion of TEC manufacturing technologies with HD pellets placement, bulk BiTe material and Aluminium plates with 30W/cm<sup>2</sup> cooling power density.
- Aluminium plates simplifies TEC mounting process and match perfectly with standard Aluminium heatsinks.
- TEC internal Assembly Solder by default: Sn-Sb, T<sub>melt</sub>=230°C



Optimal for cycling applications



RoHS Compliant

## APPLICATION TIPS

- Maximum **short time process** temperature is 220°C (TEC assembly solder has T<sub>melt</sub>=230°C).
- Maximum **long time operating** temperature is 150°C.
- Use thermoelectric cooler only with an appropriate heat sink attached to the hot side.
- Connect thermoelectric cooler to DC power supply in according to TEC polarity.
- Do not exceed DC current and voltage higher than I<sub>max</sub> and U<sub>max</sub> values.
- Use temperature ramping and avoid thermal shocks during soldering and/or baking processes.
- Check [FAQ](#) on TEC Microsystems web for more details about TECs operating and handling.

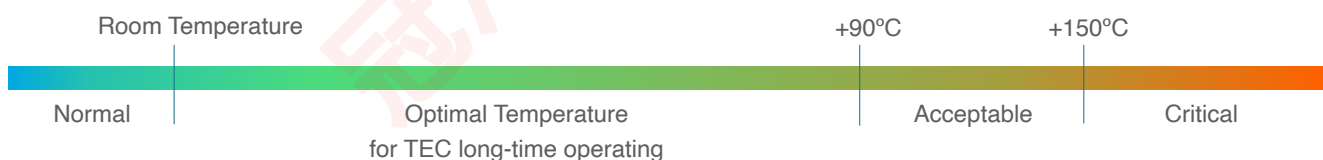

TEC Lifetime depends on Ambient Temperature ( $T_{amb}$ ) and can be estimated by Arrhenius equation

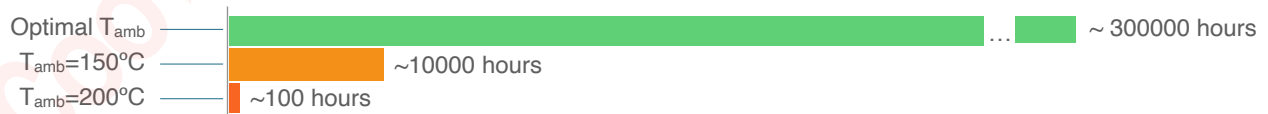

Term "Lifetime" for TEC is taken from Telcordia GR-468 Standard. The criteria of failure is TEC AC Resistance (ACR) change for more than 5%. It doesn't mean TEC stops operating, but certain performance degradation appears.



## IMPORTANT NOTES

1. Thermoelectric Cooler (TEC) performance in this datasheet is specified in typical ambient condition modes (Vacuum, +27°C; Dry N2, +50°C; Dry N2, +75°C and Dry N2, +85°C. TEC performance may differ under other conditions. Please, contact TEC Microsystems for detailed analysis and additional TEC performance info.
2. TEC ACR and  $U_{max}$  values are sensitive to ambient temperature. These values can be different from those specified in the datasheet at other ambient conditions. ACR and  $U_{max}$  rise with ambient temperature increasing.
3. TEC  $dT_{max}$  is specified at zero heatload, while  $Q_{max}$  is specified at zero  $dT$  (check Fig.1 for example). TEC  $dT_{max}$  and  $Q_{max}$  values rise with ambient temperature (check Fig. 2 for example).
4. Thermoelectric coolers have the best performance in the temperature range from near room up to +80..90°C. TEC cooling performance is getting lower at ambient temperatures below 0°C. TECs are not suitable to operate at cryogenic temperatures.

Fig. 1 - Understanding  $dT_{max}$  and  $Q_{max}$

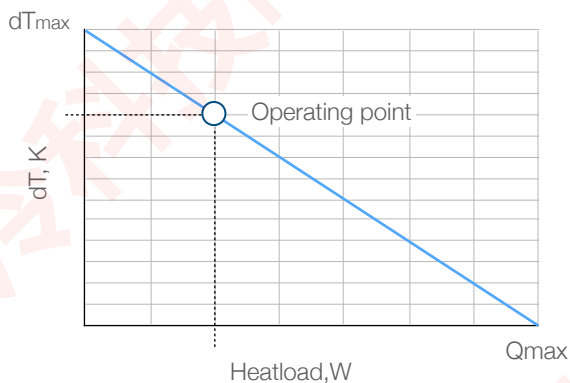
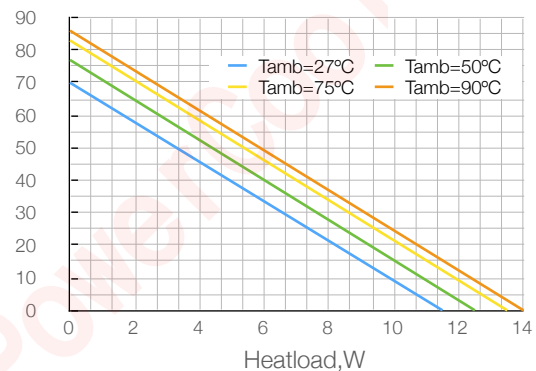

Fig. 2 - Same TEC  $dT_{max}$  and  $Q_{max}$  parameters at different ambient temperatures



5. Driving TEC at  $I_{max}$  or  $U_{max}$  level doesn't mean the max cooling performance mode. The real optimal mode may depend on operating conditions, required  $dT$  level and application heatload. In fact a better performance can be reached at operating current and voltage lower than  $I_{max}$  and  $U_{max}$  values specified in datasheet.
6. Aluminium thermoelectric coolers from 1MA10 Series can be mounted directly on Aluminium or Copper heatsinks. There is no critical CTE mismatch as it happens with standard ceramic TECs in this case. In the case of Aluminium heatsink, there is no CTE mismatch at all. However, it's recommended to avoid such hard joint methods of mounting like epoxy glue. Soft elastic materials for mounting are recommended - thermal pastes/grease or elastic silicon-based thermoconductive adhesives.
7. TEC Microsystems GmbH confirms that all thermoelectric coolers are qualified and meet the requirements of Telcordia GR-468 Standard (based on MIL-883). The up-to-date Reliability Report is available by request. TEC Microsystems GmbH warrants thermoelectric coolers lifetime no less than 250K-300K operating hours under normal application conditions.
8. Additional information about thermoelectric coolers operating and handling, all the most important questions and answers, are available on TEC Microsystems web in FAQ section ([link](#)).



## LEGAL NOTICE

---

All logos, images, trademarks and product names (collectively Materials) are proprietary to TEC Microsystems GmbH and/ or any of its affiliates, branches or subsidiaries, or other respective owners that have granted TEC Microsystems GmbH the permission and/or license to use such Materials.

All images are provided by TEC Microsystems GmbH and are subjects of copyright protection.

TEC Microsystems GmbH does not grant a copyright license (express or implied) to the Recipient, except that Recipient may reproduce the logos, images and text materials in this press-release without any alteration for non-promotional or editorial purposes only with a written note about materials owner.

## COPYRIGHT PROTECTION

---

Graphics materials and texts from this datasheet may not be used commercially without a prior response in writing on company letterhead and signed by TEC Microsystems GmbH authority.

Thank you for respecting the intellectual property rights protected by the International Copyright laws.

All Images contain TEC Microsystems GmbH hidden watermarks for the immediate proof of their origin.

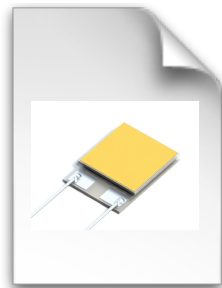

TEC Microsystems GmbH  
images



Hidden Watermark  
verification